











SMARTair™ Cylinders

Wireless and battery powered

Technical data – SMARTair™ cylinders

	Application	Ideal for office or meeting room doors
	Door profiles	Euro, Scandinavian, suitable for wooden, narrow or glass doors
	Verticals	All industries
	Traffic volume	Medium
	Exterior usage	Yes (IP55), Up to 85% humidity without condensation, Temperature (0°C and +70°C)
	Hardware compatibility and installation	Very high retrofit, No drilling, no cabling
	Power supply	Battery (up to 40.000 Cycles, max. 2 years standby)
	System management	Stand-Alone, Offline, Update on Card, Wireless online
	Multi-authentication	No
	Status information	No
	Certifications	CE

SMARTair™ cylinders – versions and profiles

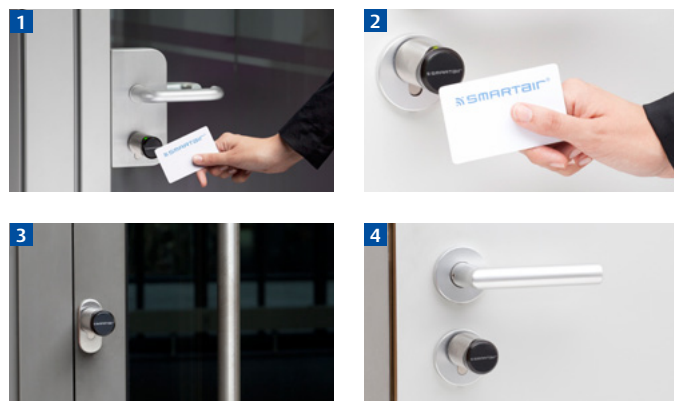

1. Suitable for glass door applications
2. RFID reader with LED (green/red signal) with 2-4cm read/write distance
3. Suitable for usage at exterior and narrow profile doors
4. Panic function: Internal knob turning always opens door (only Euro profile)

Technical drawings and dimensions

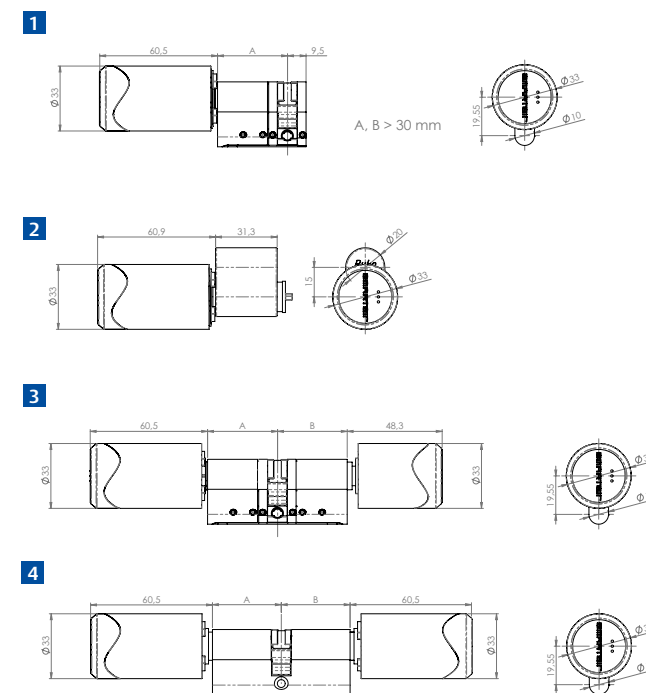

1. Single knob cylinder European profile
2. Single knob cylinder Scandinavian profile
3. Double knob cylinder European profile
4. Double knob cylinder European profile with double side electronic